

Dell™ XPS™ 14z

Owner's Manual

Computer model: L412z

Regulatory model: P24G series

Regulatory type: P24G001



Notes, Cautions, and Warnings



NOTE: A NOTE indicates important information that helps you make better use of your computer.



CAUTION: A CAUTION indicates potential damage to hardware or loss of data if instructions are not followed.



WARNING: A WARNING indicates a potential for property damage, personal injury, or death.

Information in this document is subject to change without notice.

© 2011 Dell Inc. All rights reserved.

Reproduction of these materials in any manner whatsoever without the written permission of Dell Inc. is strictly forbidden.

Trademarks used in this text: Dell™, the DELL logo, and XPS™ are trademarks of Dell Inc.; Microsoft®, Windows® and the Windows start button logo  are either trademarks or registered trademarks of Microsoft corporation in the United States and/or other countries; Bluetooth® is a registered trademark owned by Bluetooth SIG, Inc. and is used by Dell under license.

Other trademarks and trade names may be used in this document to refer to either the entities claiming the marks and names or their products. Dell Inc. disclaims any proprietary interest in trademarks and trade names other than its own.

Regulatory model: P24G series

Regulatory type: P24G001

2011 - 09

Rev. A00

Contents

| | | |
|---|--|-----------|
| 1 | Before You Begin | 7 |
| | Recommended Tools | 7 |
| | Turning Off Your Computer | 7 |
| | Before Working Inside Your Computer | 8 |
| 2 | Base Cover | 11 |
| | Removing the Base Cover | 11 |
| | Replacing the Base Cover | 12 |
| 3 | Battery | 15 |
| | Removing the Battery | 15 |
| | Replacing the Battery | 16 |
| 4 | Memory Module(s) | 17 |
| | Removing the Memory Module(s) | 17 |
| | Replacing the Memory Module(s) | 18 |

| | | |
|---|--|----|
| 5 | Wireless Mini-Card | 21 |
| | Removing the Mini-Card | 21 |
| | Replacing the Mini-Card | 23 |
| 6 | Hard Drive | 25 |
| | Removing the Hard Drive | 25 |
| | Replacing the Hard Drive | 28 |
| 7 | Coin-Cell Battery | 29 |
| | Removing the Coin-Cell Battery | 29 |
| | Replacing the Coin-Cell Battery | 30 |
| 8 | Optical Drive | 31 |
| | Removing the Optical Drive | 31 |
| | Replacing the Optical Drive | 33 |
| 9 | Hall-Sensor Board | 35 |
| | Removing the Hall-Sensor Board | 35 |
| | Replacing the Hall-Sensor Board | 37 |

| | | |
|----|--|----|
| 10 | Display-Converter Board | 39 |
| | Removing the Display-Converter Board. | 39 |
| | Replacing the Display-Converter Board | 40 |
| 11 | Heat Sink and Fan | 41 |
| | Removing the Heat Sink and Fan | 41 |
| | Replacing the Heat Sink and Fan | 42 |
| 12 | System Board | 45 |
| | Removing the System Board. | 45 |
| | Replacing the System Board. | 48 |
| | Entering the Service Tag in the BIOS | 49 |
| 13 | Power-Button Board | 51 |
| | Removing the Power-Button Board | 51 |
| | Replacing the Power-Button Board | 52 |
| 14 | Keyboard | 53 |
| | Removing the Keyboard Bracket | 53 |
| | Replacing the Keyboard Bracket | 57 |
| | Removing the Keyboard | 58 |
| | Replacing the Keyboard | 59 |

| | | |
|----|---|-----------|
| 15 | Speakers | 61 |
| | Removing the Speakers | 61 |
| | Replacing the Speakers | 64 |
| 16 | Display | 65 |
| | Display Hinge Covers | 65 |
| | Removing the Display Hinge Covers | 65 |
| | Replacing the Display Hinge Covers | 67 |
| | Display Assembly | 68 |
| | Removing the Display Assembly | 68 |
| | Replacing the Display Assembly | 69 |
| 17 | Palm-Rest Assembly | 71 |
| | Removing the Palm-Rest Assembly | 71 |
| | Replacing the Palm-Rest Assembly | 72 |
| 18 | Flashing the BIOS | 73 |

Before You Begin

This manual provides procedures for removing and installing the components in your computer. Unless otherwise noted, each procedure assumes that the following conditions exist:

- You have performed the steps in "Turning Off Your Computer" on page 7 and "Before Working Inside Your Computer" on page 8.
- You have read the safety information that shipped with your computer.
- A component can be replaced or—if purchased separately—installed by performing the removal procedure in reverse order.

Recommended Tools

The procedures in this document may require the following tools:

- Small flat-blade screwdriver
- Phillips screwdriver
- BIOS executable update program available at support.dell.com







Turning Off Your Computer

 **CAUTION: To avoid losing data, save and close all open files and exit all open programs before you turn off your computer.**

- 1 Save and close all open files and exit all open programs.
- 2 To shut down the operating system, click **Start**  and then click **Shut Down**.
- 3 Ensure that the computer is turned off. If your computer did not automatically turn off when you shut down the operating system, press and hold the power button until the computer turns off.

Before Working Inside Your Computer

Use the following safety guidelines to help protect your computer from potential damage and to help to ensure your own personal safety.



-  **WARNING:** Before working inside your computer, read the safety information that shipped with your computer. For additional safety best practices information, see the Regulatory Compliance Homepage at www.dell.com/regulatory_compliance.
-  **CAUTION:** To avoid electrostatic discharge, ground yourself by using a wrist grounding strap or by periodically touching an unpainted metal surface (such as a connector on your computer).
-  **CAUTION:** Handle components and cards with care. Do not touch the components or contacts on a card. Hold a card by its edges or by its metal mounting bracket. Hold a component such as a processor by its edges, not by its pins.
-  **CAUTION:** Only a certified service technician should perform repairs on your computer. Damage due to servicing that is not authorized by Dell is not covered by your warranty.
-  **CAUTION:** When you disconnect a cable, pull on its connector or on its pull-tab, not on the cable itself. Some cables have connectors with locking tabs; if you are disconnecting this type of cable, press in on the locking tabs before you disconnect the cable. As you pull connectors apart, keep them evenly aligned to avoid bending any connector pins. Also, before you connect a cable, ensure that both connectors are correctly oriented and aligned.
-  **CAUTION:** To avoid damaging the computer, perform the following steps before you begin working inside the computer.
 - 1 Ensure that the work surface is flat and clean to prevent the computer cover from being scratched.
 - 2 Turn off your computer (see "Turning Off Your Computer" on page 7) and all attached devices.
-  **CAUTION:** To disconnect a network cable, first unplug the cable from your computer and then unplug the cable from the network device.
 - 3 Disconnect all telephone or network cables from the computer.
 - 4 Press and eject any installed cards from the Media Card Reader.
 - 5 Disconnect your computer and all attached devices from their electrical outlets.

- 6 Disconnect all attached devices from your computer.
- 7 Remove the battery (see "Removing the Battery" on page 15).
- 8 Turn the computer top-side up, open the display, and press the power button to ground the system board.



CAUTION: Before touching anything inside your computer, ground yourself by touching an unpainted metal surface, such as the metal at the back of the computer. While you work, periodically touch an unpainted metal surface to dissipate static electricity, which could harm internal components.

Base Cover

-  **WARNING:** Before working inside your computer, read the safety information that shipped with your computer. For additional safety best practices information, see the Regulatory Compliance Homepage at www.dell.com/regulatory_compliance.
-  **CAUTION:** Only a certified service technician should perform repairs on your computer. Damage due to servicing that is not authorized by Dell is not covered by your warranty.
-  **CAUTION:** To avoid electrostatic discharge, ground yourself by using a wrist grounding strap or by periodically touching an unpainted metal surface (such as a connector on your computer).

Removing the Base Cover

- 1 Follow the instructions in "Before You Begin" on page 7.
- 2 Remove the eight screws that secure the base cover to the palm-rest assembly.
- 3 Starting from the rear end, use your fingertips to release the tabs on the base cover from the slots on the palm-rest assembly.

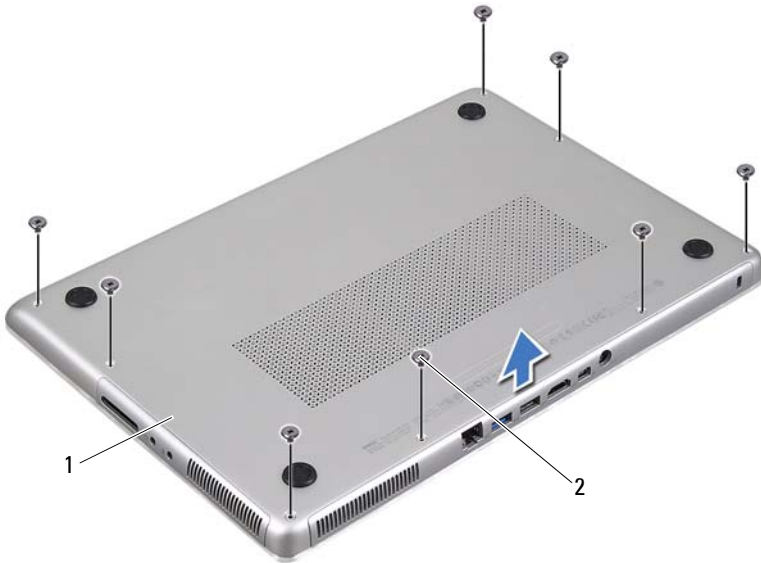

1 base cover





2 screws (8)

4 Lift the base cover off the palm-rest assembly.

Replacing the Base Cover

- 1 Follow the instructions in "Before You Begin" on page 7.
- 2 Align the tabs on the base cover with the slots on the palm-rest assembly and snap the base cover into place.
- 3 Replace the eight screws that secure the base cover to the palm-rest assembly.

Battery

-  **WARNING:** Before working inside your computer, read the safety information that shipped with your computer. For additional safety best practices information, see the Regulatory Compliance Homepage at www.dell.com/regulatory_compliance.
-  **CAUTION:** Only a certified service technician should perform repairs on your computer. Damage due to servicing that is not authorized by Dell is not covered by your warranty.
-  **CAUTION:** To avoid electrostatic discharge, ground yourself by using a wrist grounding strap or by periodically touching an unpainted metal surface (such as a connector on your computer).
-  **CAUTION:** To avoid damage to the computer, use only the battery designed for this particular Dell computer. Do not use batteries designed for other Dell computers.

Removing the Battery

- 1 Follow the instructions in "Before You Begin" on page 7.
- 2 Remove the base cover (see "Removing the Base Cover" on page 11).
- 3 Disconnect the battery cable from the system-board connector.
- 4 Remove the five screws that secure the battery to the palm-rest assembly.
- 5 Lift the battery off the palm-rest assembly.

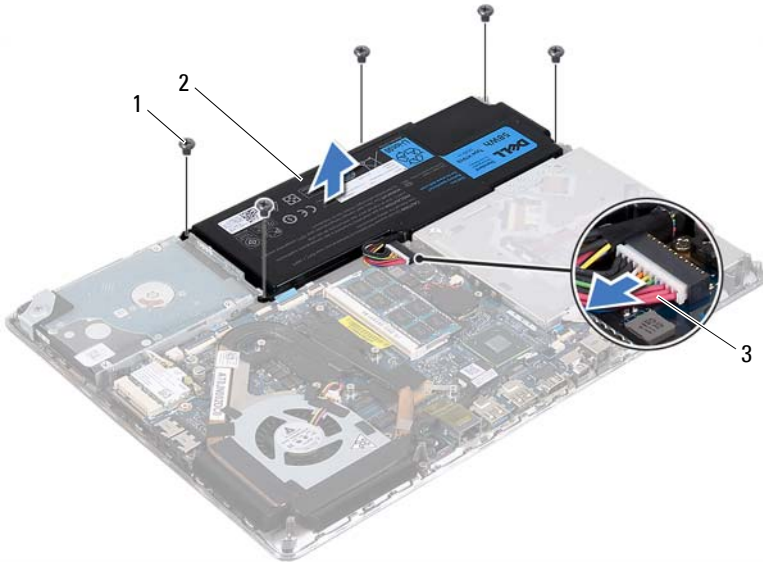





- 1 screws (5)
- 2 battery
- 3 battery cable

Replacing the Battery

CAUTION: To avoid damage to the computer, use only the battery designed for this particular Dell computer.

- 1 Follow the instructions in "Before You Begin" on page 7.
- 2 Place the battery on the palm-rest assembly.
- 3 Replace the five screws that secure the battery to the palm-rest assembly.
- 4 Connect the battery cable to the system-board connector.
- 5 Replace the base cover (see "Replacing the Base Cover" on page 12).

Memory Module(s)

-  **WARNING:** Before working inside your computer, read the safety information that shipped with your computer. For additional safety best practices information, see the Regulatory Compliance Homepage at www.dell.com/regulatory_compliance.
-  **CAUTION:** Only a certified service technician should perform repairs on your computer. Damage due to servicing that is not authorized by Dell is not covered by your warranty.
-  **CAUTION:** To avoid electrostatic discharge, ground yourself by using a wrist grounding strap or by periodically touching an unpainted metal surface (such as a connector on your computer).
-  **CAUTION:** To help prevent damage to the system board, remove the main battery (see "Removing the Battery" on page 15) before working inside the computer.

You can increase your computer memory by installing memory modules on the system board. See "Specifications" at support.dell.com/manuals for information on the type of memory supported by your computer.

 **NOTE:** Memory modules purchased from Dell are covered under your computer warranty.

Your computer has two user-accessible SODIMM connectors. The primary memory module can be accessed by removing the back cover. The secondary memory module can be accessed by removing the system board.

Removing the Memory Module(s)

- 1 Follow the instructions in "Before You Begin" on page 7.
- 2 Remove the base cover (see "Removing the Base Cover" on page 11).
- 3 Remove the battery (see "Removing the Battery" on page 15).

 **CAUTION:** To help prevent damage to the memory-module connector, do not use tools to spread the memory module securing clips.

 **NOTE:** To access the second memory module, remove the system board and turn it over. To remove the system board, see "Removing the System Board" on page 45.

- 4 Use your fingertips to carefully spread apart the securing clips on each end of the memory-module connector until the memory module pops up.

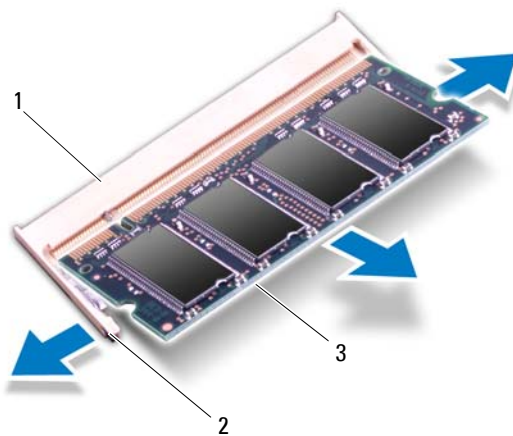

- 1 memory-module connector 2 securing clips (2)
3 memory module

- 5 Remove the memory module from the memory-module connector.

Replacing the Memory Module(s)

- 1 Follow the instructions in "Before You Begin" on page 7.
- 2 Align the notch in the memory module with the tab in the memory-module connector.

- 3 Slide the memory module firmly into the memory-module connector at a 45-degree angle, and press the memory module down until it clicks into place. If you do not hear the click, remove the memory module and reinstall it.

 **NOTE:** Replace the system board after replacing the secondary memory module. To replace the system board, see "Replacing the System Board" on page 48.

 **NOTE:** If the memory module is not installed properly, the computer may not boot.

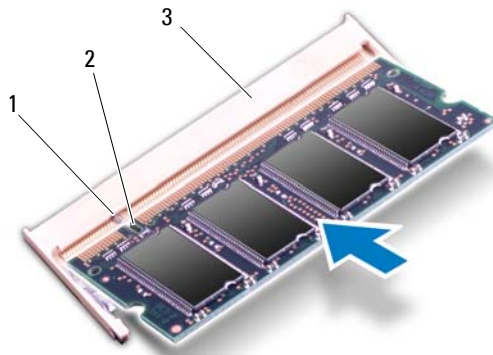

- | | | | |
|---|-------------------------|---|-------|
| 1 | tab | 2 | notch |
| 3 | memory-module connector | | |

- 4 Replace the battery (see "Replacing the Battery" on page 16).
- 5 Replace the base cover (see "Replacing the Base Cover" on page 12).
- 6 Connect the AC adapter to your computer and an electrical outlet.

 **CAUTION:** Before turning on the computer, replace all screws and ensure that no stray screws remain inside the computer. Failure to do so may result in damage to the computer.





- 7 Turn on the computer.

As the computer boots, it detects the additional memory and automatically updates the system configuration information.

To confirm the amount of memory installed in the computer:

Click **Start**  → **Control Panel** → **System**.

Wireless Mini-Card

-  **WARNING:** Before working inside your computer, read the safety information that shipped with your computer. For additional safety best practices information, see the Regulatory Compliance Homepage at www.dell.com/regulatory_compliance.
-  **CAUTION:** Only a certified service technician should perform repairs on your computer. Damage due to servicing that is not authorized by Dell is not covered by your warranty.
-  **CAUTION:** To avoid electrostatic discharge, ground yourself by using a wrist grounding strap or by periodically touching an unpainted metal surface (such as a connector on your computer).
-  **CAUTION:** To help prevent damage to the system board, remove the main battery (see "Removing the Battery" on page 15) before working inside the computer.
-  **NOTE:** Dell does not guarantee compatibility or provide support for Mini-Cards from sources other than Dell.

If you ordered a wireless Mini-Card with your computer, the card is already installed.

Your computer has one half Mini-Card slot which supports a Wireless Local Area Network (WLAN) + Bluetooth combo card.

-  **NOTE:** Depending on the configuration of the computer when it was sold, the Mini-Card slot may or may not have a Mini-Card installed.

Removing the Mini-Card

- 1 Follow the instructions in "Before You Begin" on page 7.
- 2 Remove the base cover (see "Removing the Base Cover" on page 11).
- 3 Remove the battery (see "Removing the Battery" on page 15).
- 4 Disconnect the antenna cables from the Mini-Card.
- 5 Remove the screw that secures the Mini-Card to the system board.

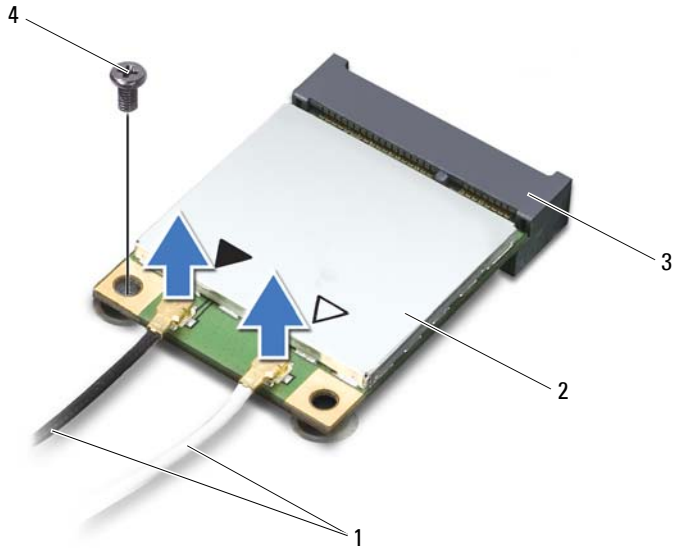

- | | | | |
|---|------------------------|---|-----------|
| 1 | antenna cables (2) | 2 | Mini-Card |
| 3 | system-board connector | 4 | screw |

6 Lift the Mini-Card out of the system-board connector.

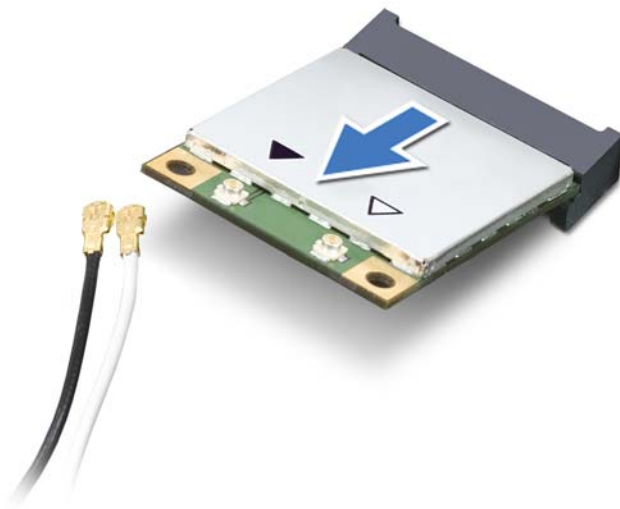

- △ **CAUTION:** When the Mini-Card is not in the computer, store it in protective antistatic packaging. For more information, see "Protecting Against Electrostatic Discharge" in the safety information that shipped with your computer.

Replacing the Mini-Card

- 1 Follow the instructions in "Before You Begin" on page 7.
 - 2 Remove the new Mini-Card from its packaging.
- △ **CAUTION:** Use firm and even pressure to slide the Mini-Card into place. If you use excessive force, you may damage the connector.
- △ **CAUTION:** The connectors are keyed to ensure correct insertion. If you feel resistance, check the connectors on the Mini-Card and on the system board, and realign the Mini-Card.
- △ **CAUTION:** To avoid damage to the Mini-Card, never place cables under the Mini-Card.

- 3 Insert the Mini-Card connector at a 45-degree angle into the system-board connector.
- 4 Press the other end of the Mini-Card down into the slot on the system board and replace the screw that secures the Mini-Card to the system board.
- 5 Connect the appropriate antenna cables to the Mini-Card you are installing.

| Connectors on the Mini-Card | Antenna Cable Color Scheme |
|---|----------------------------|
| WLAN + Bluetooth (2 antenna cables) | |
| Main WLAN + Bluetooth (white triangle) | white |
| Auxiliary WLAN + Bluetooth (black triangle) | black |

- 6 Replace the battery (see "Replacing the Battery" on page 16).
- 7 Replace the base cover (see "Replacing the Base Cover" on page 12).

 **CAUTION: Before turning on the computer, replace all screws and ensure that no stray screws remain inside the computer. Failure to do so may result in damage to the computer.**

- 8 Install the drivers and utilities for your Mini-Card, as required.

 **NOTE:** If you are installing a Mini-Card from a source other than Dell, you must install the appropriate drivers and utilities.

Hard Drive

 **WARNING:** Before working inside your computer, read the safety information that shipped with your computer. For additional safety best practices information, see the Regulatory Compliance Homepage at www.dell.com/regulatory_compliance.

 **WARNING:** If you remove the hard drive from the computer when the drive is hot, *do not touch* the metal housing of the hard drive.

 **CAUTION:** Only a certified service technician should perform repairs on your computer. Damage due to servicing that is not authorized by Dell is not covered by your warranty.

 **CAUTION:** To avoid electrostatic discharge, ground yourself by using a wrist grounding strap or by periodically touching an unpainted metal surface (such as a connector on your computer).

 **CAUTION:** To help prevent damage to the system board, remove the main battery (see "Removing the Battery" on page 15) before working inside the computer.

 **CAUTION:** To prevent data loss, turn off your computer (see "Turning Off Your Computer" on page 7) before removing the hard drive. Do not remove the hard drive while the computer is On or in Sleep state.

 **CAUTION:** Hard drives are extremely fragile. Exercise care when handling the hard drive.

 **NOTE:** Dell does not guarantee compatibility or provide support for hard drives from sources other than Dell.

 **NOTE:** If you are installing a hard drive from a source other than Dell, you need to install an operating system, drivers, and utilities on the new hard drive.

Removing the Hard Drive

- 1 Follow the instructions in "Before You Begin" on page 7.
- 2 Remove the base cover (see "Removing the Base Cover" on page 11).
- 3 Remove the battery (see "Removing the Battery" on page 15).
- 4 Remove the three screws that secure the hard-drive assembly to the palm-rest assembly.

- 5 Lift the connector latch and pull the pull-tab to disconnect the hard-drive cable from the system-board connector.
- 6 Slide the hard-drive assembly away from the bracket on the palm-rest assembly.
- 7 Lift the hard-drive assembly out of the palm-rest assembly.

CAUTION: When the hard drive is not in the computer, store it in protective antistatic packaging (see "Protecting Against Electrostatic Discharge" in the safety instructions that shipped with your computer).

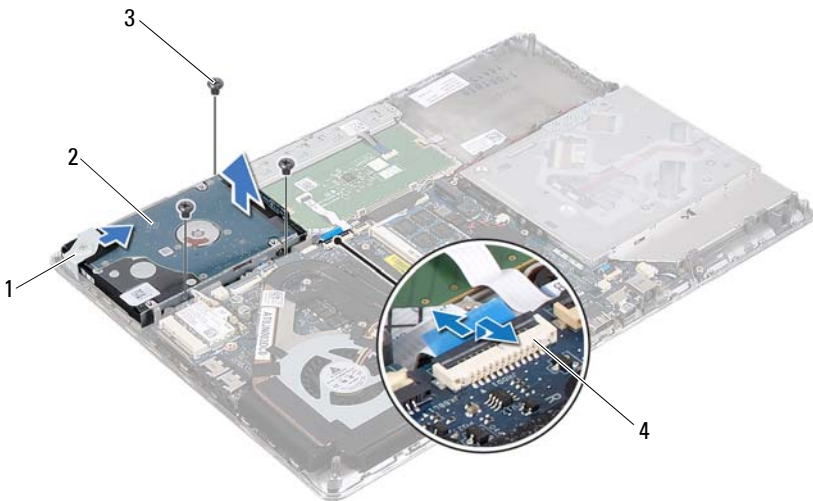

- | | | | |
|---|------------|---|----------------------------|
| 1 | bracket | 2 | hard-drive assembly |
| 3 | screws (3) | 4 | hard-drive cable connector |

- 8 Remove the four screws that secure the hard-drive bracket to the hard drive.
- 9 Lift the hard-drive bracket off the hard drive.

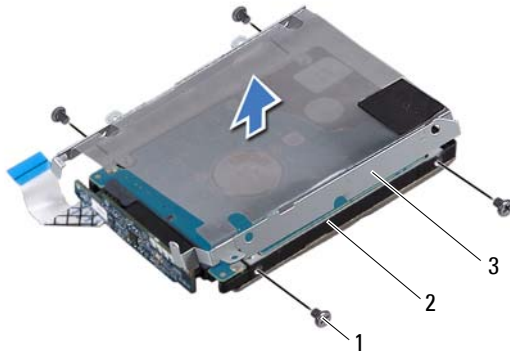

- 1 screws (4)
- 2 hard drive
- 3 hard-drive bracket

10 Disconnect the interposer from the hard drive.

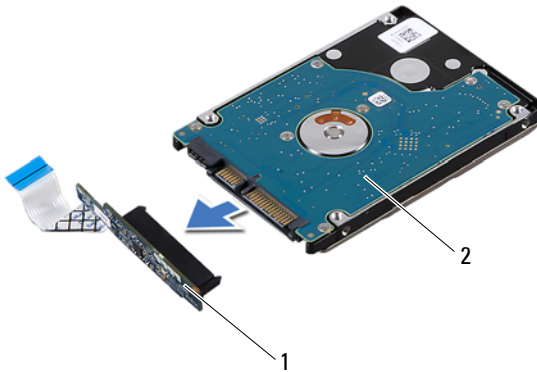

- 1 interposer
- 2 hard drive





Replacing the Hard Drive

- 1 Follow the instructions in "Before You Begin" on page 7.
- 2 Remove the new hard drive from its packaging.
Save the original packaging for storing or shipping the hard drive.
- 3 Connect the interposer to the hard drive.
- 4 Place the hard-drive bracket on the hard drive.
- 5 Replace the four screws that secure the hard-drive bracket to the hard drive.
- 6 Slide the hard-drive assembly into the bracket on the palm-rest assembly.
- 7 Replace the three screws that secure the hard-drive assembly to the palm-rest assembly.
- 8 Slide the hard-drive cable into the system-board connector and press down on the connector latch to secure the cable.
- 9 Replace the battery (see "Replacing the Battery" on page 16).
- 10 Replace the base cover (see "Replacing the Base Cover" on page 12).



CAUTION: Before turning on the computer, replace all screws and ensure that no stray screws remain inside the computer. Failure to do so may result in damage to the computer.

Coin-Cell Battery

-  **WARNING:** Before working inside your computer, read the safety information that shipped with your computer. For additional safety best practices information, see the Regulatory Compliance Homepage at www.dell.com/regulatory_compliance.
-  **CAUTION:** Only a certified service technician should perform repairs on your computer. Damage due to servicing that is not authorized by Dell is not covered by your warranty.
-  **CAUTION:** To avoid electrostatic discharge, ground yourself by using a wrist grounding strap or by periodically touching an unpainted metal surface (such as a connector on your computer).
-  **CAUTION:** To help prevent damage to the system board, remove the main battery (see "Removing the Battery" on page 15) before working inside the computer.

Removing the Coin-Cell Battery

- 1 Follow the instructions in "Before You Begin" on page 7.
- 2 Remove the base cover (see "Removing the Base Cover" on page 11).
- 3 Remove the battery (see "Removing the Battery" on page 15).
- 4 Disconnect the coin-cell battery cable from the system-board connector.
- 5 Peel the coin-cell battery off the system board.

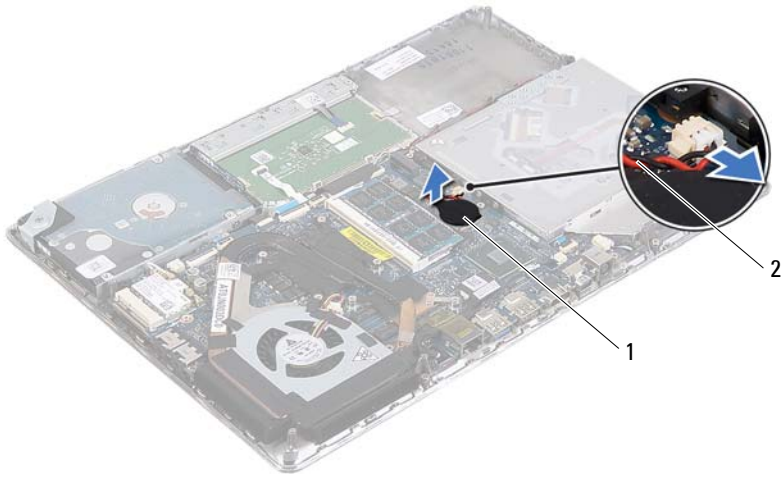

1 coin-cell-battery

2 coin-cell battery cable





Replacing the Coin-Cell Battery

- 1 Follow the instructions in "Before You Begin" on page 7.
- 2 Adhere the coin-cell battery to the system board.
- 3 Connect the coin-cell battery cable to the system-board connector.
- 4 Replace the battery (see "Replacing the Battery" on page 16).
- 5 Replace the base cover (see "Replacing the Base Cover" on page 12).



CAUTION: Before turning on the computer, replace all screws and ensure that no stray screws remain inside the computer. Failure to do so may result in damage to the computer.

Optical Drive

-  **WARNING:** Before working inside your computer, read the safety information that shipped with your computer. For additional safety best practices information, see the Regulatory Compliance Homepage at www.dell.com/regulatory_compliance.
-  **CAUTION:** Only a certified service technician should perform repairs on your computer. Damage due to servicing that is not authorized by Dell is not covered by your warranty.
-  **CAUTION:** To avoid electrostatic discharge, ground yourself by using a wrist grounding strap or by periodically touching an unpainted metal surface (such as a connector on your computer).
-  **CAUTION:** To help prevent damage to the system board, remove the main battery (see "Removing the Battery" on page 15) before working inside the computer.

Removing the Optical Drive

- 1 Follow the instructions in "Before You Begin" on page 7.
- 2 Remove the base cover (see "Removing the Base Cover" on page 11).
- 3 Remove the battery (see "Removing the Battery" on page 15).
- 4 Remove the screw that secures the optical-drive assembly to the palm-rest assembly.
- 5 Slide the optical-drive assembly to the side to release it from the bracket and tabs on the palm-rest assembly.

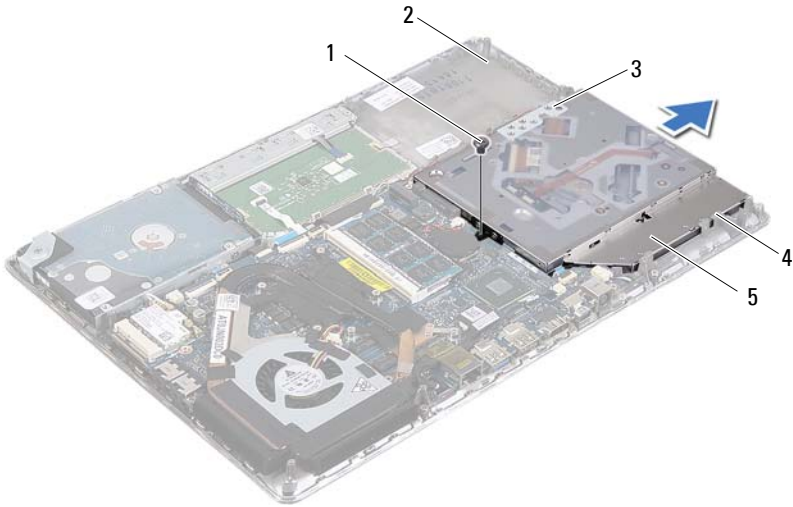

- 1 screw
- 2 palm-rest assembly
- 3 bracket
- 4 tabs (3)
- 5 optical-drive assembly

- 6 Remove the two screws that secure the optical-drive bracket to the optical drive.
- 7 Remove the optical-drive bracket from the optical drive.

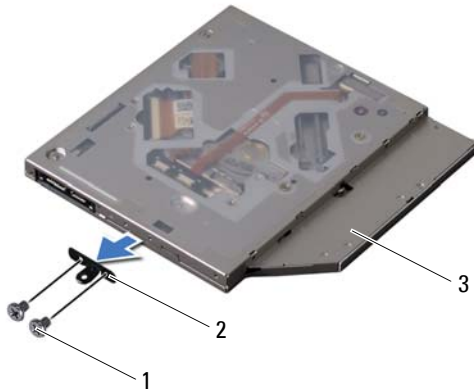





- 1 screws (2)
- 2 optical-drive bracket
- 3 optical drive

Replacing the Optical Drive

- 1 Follow the instructions in "Before You Begin" on page 7.
- 2 Place the optical-drive bracket in position.
- 3 Replace the two screws that secure the optical-drive bracket to the optical drive.
- 4 Slide the optical-drive assembly into the bracket and tabs on the palm-rest assembly.
- 5 Replace the screw that secures the optical-drive assembly to the palm-rest assembly.
- 6 Replace the battery (see "Replacing the Battery" on page 16).
- 7 Replace the base cover (see "Replacing the Base Cover" on page 12).

CAUTION: Before turning on the computer, replace all screws and ensure that no stray screws remain inside the computer. Failure to do so may result in damage to the computer.

Hall-Sensor Board

-  **WARNING:** Before working inside your computer, read the safety information that shipped with your computer. For additional safety best practices information, see the Regulatory Compliance Homepage at www.dell.com/regulatory_compliance.
-  **CAUTION:** Only a certified service technician should perform repairs on your computer. Damage due to servicing that is not authorized by Dell is not covered by your warranty.
-  **CAUTION:** To avoid electrostatic discharge, ground yourself by using a wrist grounding strap or by periodically touching an unpainted metal surface (such as a connector on your computer).
-  **CAUTION:** To help prevent damage to the system board, remove the main battery (see "Removing the Battery" on page 15) before working inside the computer.

Removing the Hall-Sensor Board

- 1 Follow the instructions in "Before You Begin" on page 7.
- 2 Remove the base cover (see "Removing the Base Cover" on page 11).
- 3 Remove the battery (see "Removing the Battery" on page 15).
- 4 Remove the hard drive (see "Removing the Hard Drive" on page 25).
- 5 Without pulling hard on the sponge pad, carefully lift the sponge pad from the inside edge of the computer.



- 1 sponge pad
- 6 Lift the connector latch and pull the pull-tab to disconnect the hall-sensor-board cable from the system-board connector.
- 7 Remove the screw that secures the hall-sensor board to the palm-rest assembly.
- 8 Lift the hall-sensor board away from the palm-rest assembly.

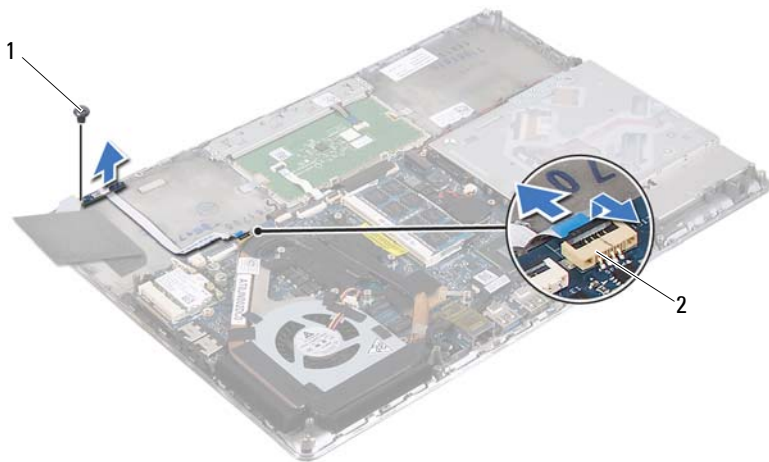

1 screw

2 system-board connector





Replacing the Hall-Sensor Board

- 1 Follow the instructions in "Before You Begin" on page 7.
- 2 Align the screw hole on the hall-sensor board with the screw hole on the palm-rest assembly.
- 3 Replace the screw that secures the hall-sensor board to the palm-rest assembly.
- 4 Slide the hall-sensor-board cable into the system-board connector and press down on the connector latch to secure the cable.
- 5 Adhere the sponge pad to the palm-rest assembly.
- 6 Replace the hard drive (see "Replacing the Hard Drive" on page 28).
- 7 Replace the battery (see "Replacing the Battery" on page 16).
- 8 Replace the base cover (see "Replacing the Base Cover" on page 12).



CAUTION: Before turning on the computer, replace all screws and ensure that no stray screws remain inside the computer. Failure to do so may result in damage to the computer.

Display-Converter Board

-  **WARNING:** Before working inside your computer, read the safety information that shipped with your computer. For additional safety best practices information, see the Regulatory Compliance Homepage at www.dell.com/regulatory_compliance.
-  **CAUTION:** Only a certified service technician should perform repairs on your computer. Damage due to servicing that is not authorized by Dell is not covered by your warranty.
-  **CAUTION:** To avoid electrostatic discharge, ground yourself by using a wrist grounding strap or by periodically touching an unpainted metal surface (such as a connector on your computer).
-  **CAUTION:** To help prevent damage to the system board, remove the main battery (see "Removing the Battery" on page 15) before working inside the computer.

Removing the Display-Converter Board

- 1 Follow the instructions in "Before You Begin" on page 7.
- 2 Remove the base cover (see "Removing the Base Cover" on page 11).
- 3 Remove the battery (see "Removing the Battery" on page 15).
- 4 Disconnect the display-converter-board cable from the system-board connector.
- 5 Remove the two screws that secure the display-converter board to the palm-rest assembly.
- 6 Without pulling hard on the display-converter board, carefully lift the display-converter board and turn it over.
- 7 Disconnect the display-converter-board cable and the display cable from the connectors on the display-converter board.
- 8 Lift the display-converter board out of the computer.

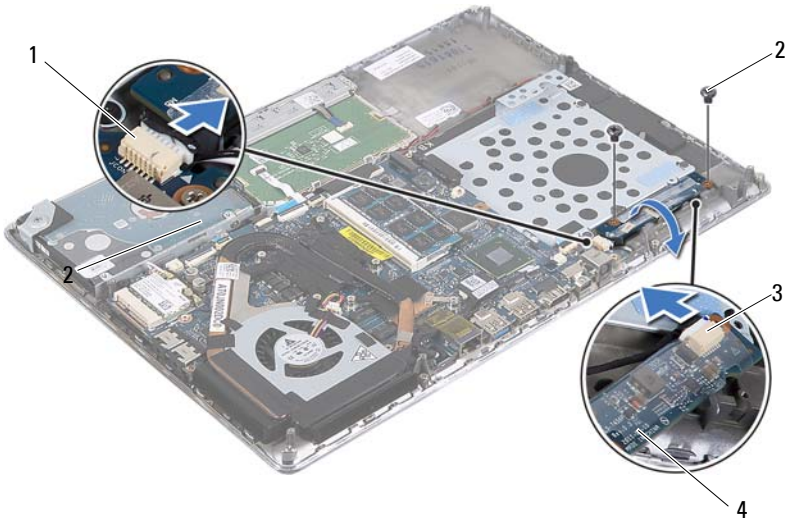

- | | | | |
|---|-------------------------|---|-------------------------|
| 1 | system-board connector | 2 | screws (2) |
| 3 | display cable connector | 4 | display-converter board |

Replacing the Display-Converter Board

- 1 Follow the instructions in "Before You Begin" on page 7.
- 2 Connect the display-converter-board cable, and the display cable to the connectors on the display-converter board.
- 3 Align the screw holes on the display-converter board with the screw holes on the palm-rest assembly.
- 4 Replace the two screws that secure the display-converter board to the palm-rest assembly.
- 5 Connect the display-converter-board cable to the system-board connector.
- 6 Replace the battery (see "Replacing the Battery" on page 16).
- 7 Replace the base cover (see "Replacing the Base Cover" on page 12).

CAUTION: Before turning on the computer, replace all screws and ensure that no stray screws remain inside the computer. Failure to do so may result in damage to the computer.

Heat Sink and Fan

 **WARNING:** Before working inside your computer, read the safety information that shipped with your computer. For additional safety best practices information, see the Regulatory Compliance Homepage at www.dell.com/regulatory_compliance.

 **WARNING:** If you remove the heat sink from the computer when the heat sink is hot, *do not touch* the metal housing of the heat sink.

 **CAUTION:** Only a certified service technician should perform repairs on your computer. Damage due to servicing that is not authorized by Dell is not covered by your warranty.

 **CAUTION:** To avoid electrostatic discharge, ground yourself by using a wrist grounding strap or by periodically touching an unpainted metal surface (such as a connector on your computer).

 **CAUTION:** To help prevent damage to the system board, remove the main battery (see "Removing the Battery" on page 15) before working inside the computer.

Removing the Heat Sink and Fan

- 1 Follow the instructions in "Before You Begin" on page 7.
- 2 Remove the base cover (see "Removing the Base Cover" on page 11).
- 3 Remove the battery (see "Removing the Battery" on page 15).
- 4 Using your fingertips gently peel off the display cable tape from the heat sink.
- 5 Disconnect the fan cable from the system-board connector.
- 6 In sequential order (indicated on the heat sink), remove the six screws that secure the heat sink to the system board.
- 7 Lift the heat sink and fan away from the system board.

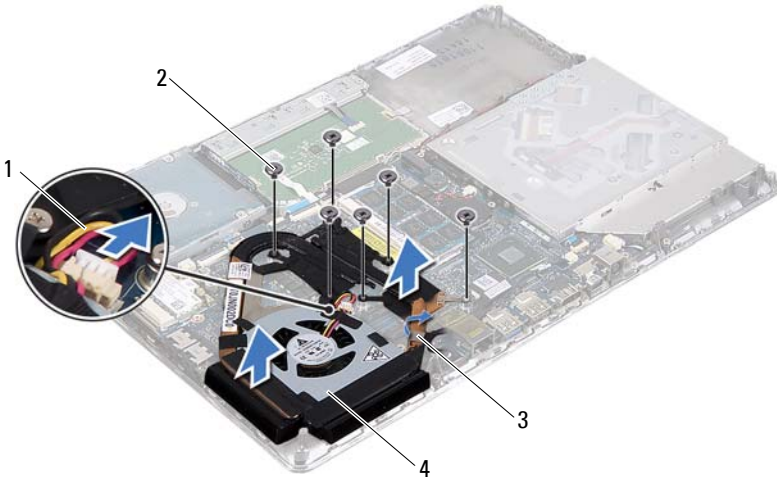

- | | | | |
|---|--------------------|---|-------------------|
| 1 | fan cable | 2 | screws (6) |
| 3 | display cable tape | 4 | heat sink and fan |

Replacing the Heat Sink and Fan

NOTE: The original thermal grease can be reused if the original system board and heat sink are reinstalled together. If either the system board or the heat sink is replaced, use the thermal pad provided in the kit to ensure that thermal conductivity is achieved.





- 1 Follow the instructions in "Before You Begin" on page 7.
- 2 Clean the thermal grease from the bottom of the heat sink and reapply it.
- 3 Align the screw holes on the heat sink with the screw holes on the system board.
- 4 In sequential order (indicated on the heat sink), replace the six screws that secure the heat sink to the system board.
- 5 Connect the fan cable to the system-board connector.
- 6 Adhere the display cable tape to the heat sink.

- 7 Replace the battery (see "Replacing the Battery" on page 16).
- 8 Replace the base cover (see "Replacing the Base Cover" on page 12).



CAUTION: Before turning on the computer, replace all screws and ensure that no stray screws remain inside the computer. Failure to do so may result in damage to the computer.

System Board

-  **WARNING:** Before working inside your computer, read the safety information that shipped with your computer. For additional safety best practices information, see the Regulatory Compliance Homepage at www.dell.com/regulatory_compliance.
-  **CAUTION:** Only a certified service technician should perform repairs on your computer. Damage due to servicing that is not authorized by Dell is not covered by your warranty.
-  **CAUTION:** To avoid electrostatic discharge, ground yourself by using a wrist grounding strap or by periodically touching an unpainted metal surface (such as a connector on your computer).
-  **CAUTION:** To help prevent damage to the system board, remove the main battery (see "Removing the Battery" on page 15) before working inside the computer.
-  **CAUTION:** Handle components and cards by their edges, and avoid touching pins and contacts.

Removing the System Board

- 1 Follow the instructions in "Before You Begin" on page 7.
- 2 Remove any installed card or blank from the Media Card Reader.
- 3 Remove the base cover (see "Removing the Base Cover" on page 11).
- 4 Remove the battery (see "Removing the Battery" on page 15).
- 5 Remove the Mini-Card (see "Removing the Mini-Card" on page 21).
- 6 Remove the hard drive (see "Removing the Hard Drive" on page 25).
- 7 Remove the coin-cell battery (see "Removing the Coin-Cell Battery" on page 29).
- 8 Remove the optical drive (see "Removing the Optical Drive" on page 31).
- 9 Remove the heat sink and fan (see "Removing the Heat Sink and Fan" on page 41).
- 10 Gently peel off the keyboard-cable pull tab from the keyboard cable connector on the system board.

- 11 Disconnect the speaker cable from the system-board connector.
- 12 Lift the connector latch and pull the pull-tab to disconnect the keyboard cable, touch-pad cable, keyboard-backlight cable, and hall-sensor cable from the system-board connectors.

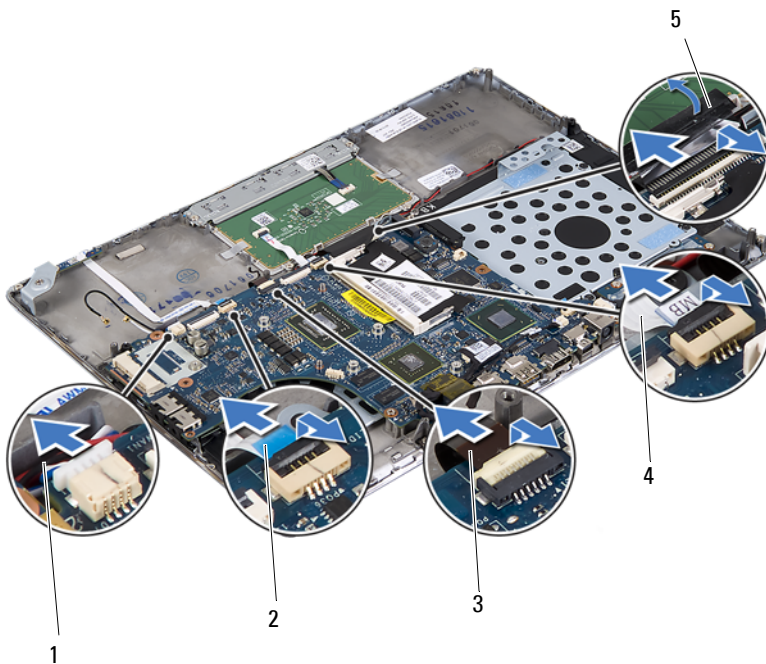

- | | | | |
|---|--------------------------|---|-------------------|
| 1 | speaker cable | 2 | hall-sensor cable |
| 3 | keyboard backlight cable | 4 | touch-pad cable |
| 5 | keyboard cable pull-tab | | |

- 13 Gently peel off the tape from the network connector on the system board.
- 14 Lift the connector latch and pull the pull-tab to disconnect the power-button board cable from the system-board connector.
- 15 Disconnect the display cable, ambient-light-sensor cable, and display-converter board cable from the system-board connectors.

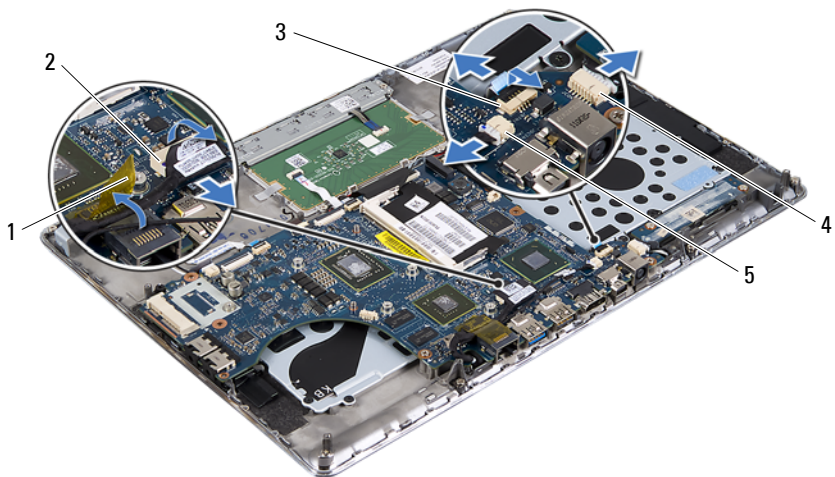

- | | | | |
|---|--------------------------------------|---|---|
| 1 | tape | 2 | display cable connector |
| 3 | power-button board cable | 4 | display-converter board cable connector |
| 5 | ambient-light-sensor cable connector | | |

- 16** Remove the five screws that secure the system board to the palm-rest assembly.
- 17** Lift the system board off the palm-rest assembly.
- 18** Remove the memory module(s) (see "Removing the Memory Module(s)" on page 17).

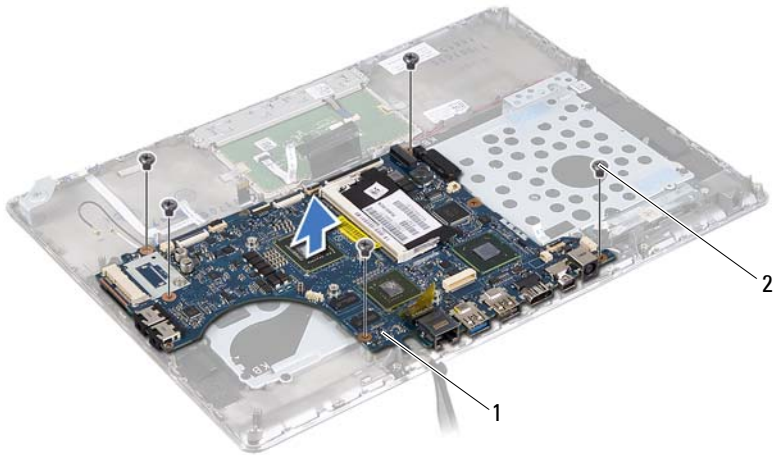

1 system board

2 screws (5)

Replacing the System Board

- 1 Follow the instructions in "Before You Begin" on page 7.
- 2 Replace the memory module(s) (see "Replacing the Memory Module(s)" on page 18).
- 3 Place the system board on the palm-rest assembly.
- 4 Replace the five screws that secure the system board to the palm-rest assembly.
- 5 Slide the power-button board cable into the system-board connector and press down on the connector latch to secure the cable.
- 6 Connect the display cable, ambient-light-sensor cable, and display-converter board cable to the system-board connectors.
- 7 Adhere the tape over the network connector on the system board.
- 8 Connect the speaker cable to the system-board connector.
- 9 Slide the keyboard cable, touch-pad cable, keyboard-backlight cable, and hall-sensor cable into the system board connectors and press down on the connector latch to secure the cable.

- 10 Adhere the pull-tab on the keyboard cable over the keyboard cable connector on the system board.
- 11 Replace the heat sink and fan (see "Replacing the Heat Sink and Fan" on page 42).
- 12 Replace the optical drive (see "Replacing the Optical Drive" on page 33).
- 13 Replace the coin-cell battery (see "Replacing the Coin-Cell Battery" on page 30).
- 14 Replace the hard drive (see "Replacing the Hard Drive" on page 28).
- 15 Replace the Mini-Card (see "Replacing the Mini-Card" on page 23).
- 16 Replace the battery (see "Replacing the Battery" on page 16).
- 17 Replace the base cover (see "Replacing the Base Cover" on page 12).
- 18 Replace any blank or card you removed from the Media Card Reader.



CAUTION: Before turning on the computer, replace all screws and ensure that no stray screws remain inside the computer. Failure to do so may result in damage to the computer.

- 19 Turn on the computer.







NOTE: After you have replaced the system board, enter the computer Service Tag in the BIOS of the replacement system board.

- 20 Enter the Service Tag (see "Entering the Service Tag in the BIOS" on page 49).

Entering the Service Tag in the BIOS

- 1 Ensure that the AC adapter is plugged in and that the main battery is installed properly.
- 2 Turn on the computer.
- 3 Press <F2> during POST to enter the System Setup program.
- 4 Navigate to the Security tab and enter the Service Tag in the Set Service Tag field.

Power-Button Board

-  **WARNING:** Before working inside your computer, read the safety information that shipped with your computer. For additional safety best practices information, see the Regulatory Compliance Homepage at www.dell.com/regulatory_compliance.
-  **CAUTION:** Only a certified service technician should perform repairs on your computer. Damage due to servicing that is not authorized by Dell is not covered by your warranty.
-  **CAUTION:** To avoid electrostatic discharge, ground yourself by using a wrist grounding strap or by periodically touching an unpainted metal surface (such as a connector on your computer).
-  **CAUTION:** To help prevent damage to the system board, remove the main battery (see "Removing the Battery" on page 15) before working inside the computer.

Removing the Power-Button Board

- 1 Follow the instructions in "Before You Begin" on page 7.
- 2 Remove the system board (see "Removing the System Board" on page 45).
- 3 Remove the two screws that secure the power-button board to the palm-rest assembly.
- 4 Lift the power-button board along with the cable away from the palm-rest assembly.

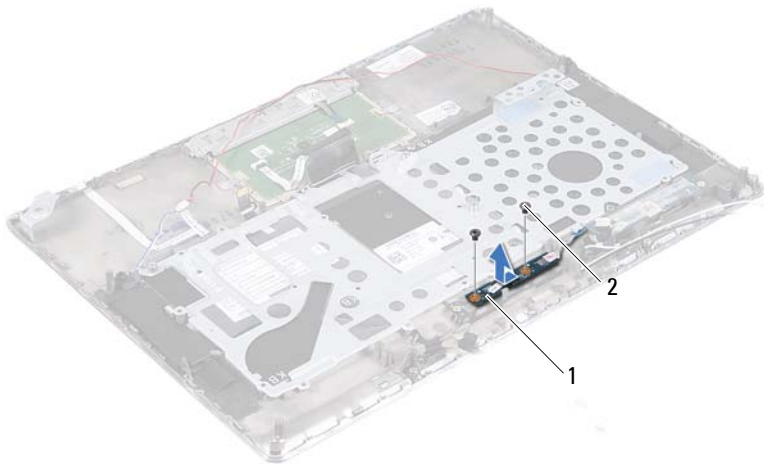

1 power-button board

2 screws (2)





Replacing the Power-Button Board

- 1 Follow the instructions in "Before You Begin" on page 7.
- 2 Use the alignment posts to place the power-button board on the palm-rest assembly.
- 3 Replace the two screws that secure the power-button board to the palm-rest assembly.
- 4 Replace the system board (see "Replacing the System Board" on page 48).



CAUTION: Before turning on the computer, replace all screws and ensure that no stray screws remain inside the computer. Failure to do so may result in damage to the computer.

Keyboard

-  **WARNING:** Before working inside your computer, read the safety information that shipped with your computer. For additional safety best practices information, see the Regulatory Compliance Homepage at www.dell.com/regulatory_compliance.
-  **CAUTION:** Only a certified service technician should perform repairs on your computer. Damage due to servicing that is not authorized by Dell is not covered by your warranty.
-  **CAUTION:** To avoid electrostatic discharge, ground yourself by using a wrist grounding strap or by periodically touching an unpainted metal surface (such as a connector on your computer).
-  **CAUTION:** To help prevent damage to the system board, remove the main battery (see "Removing the Battery" on page 15) before working inside the computer.

Removing the Keyboard Bracket

- 1 Follow the instructions in "Before You Begin" on page 7.
- 2 Remove the system board (see "Removing the System Board" on page 45).
- 3 Remove the 18 screws that secure the keyboard bracket to the palm-rest assembly.

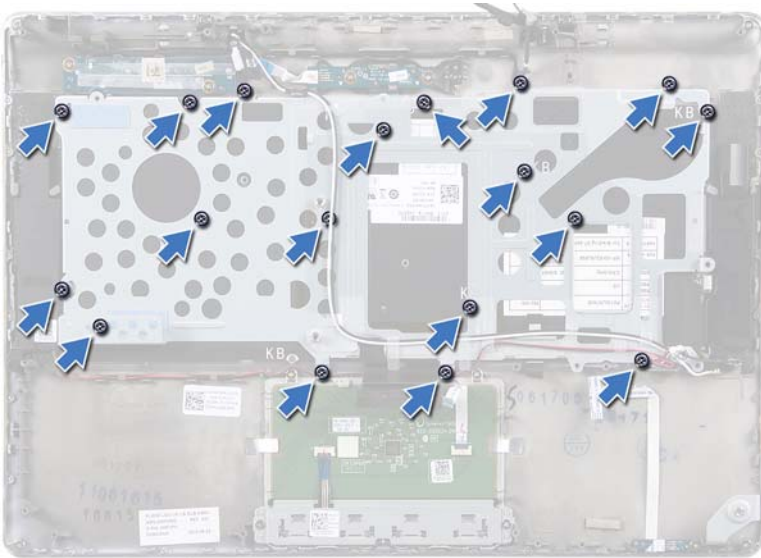

- 4 Make a note of the speakers cable routing and remove the speaker cables from the routing guides.

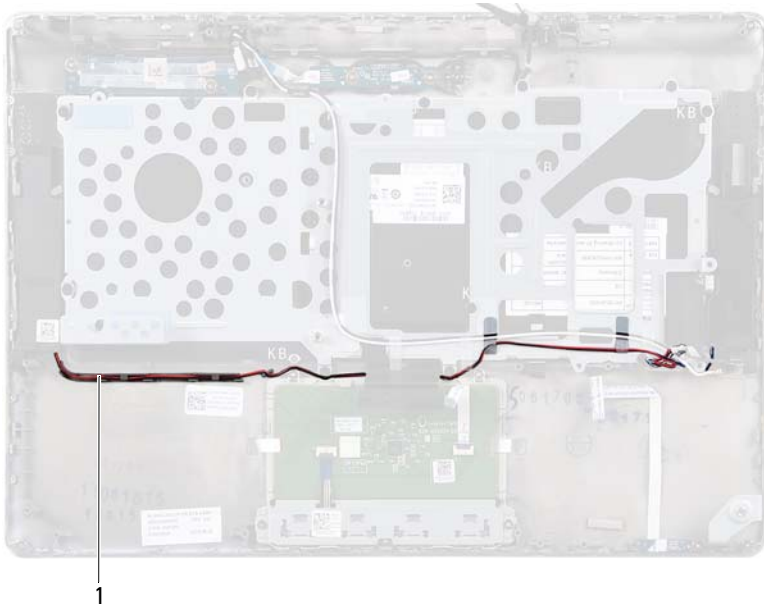

1 speakers cable

5 Make a note of the antenna cables routing and remove the antenna cables from the routing guides.

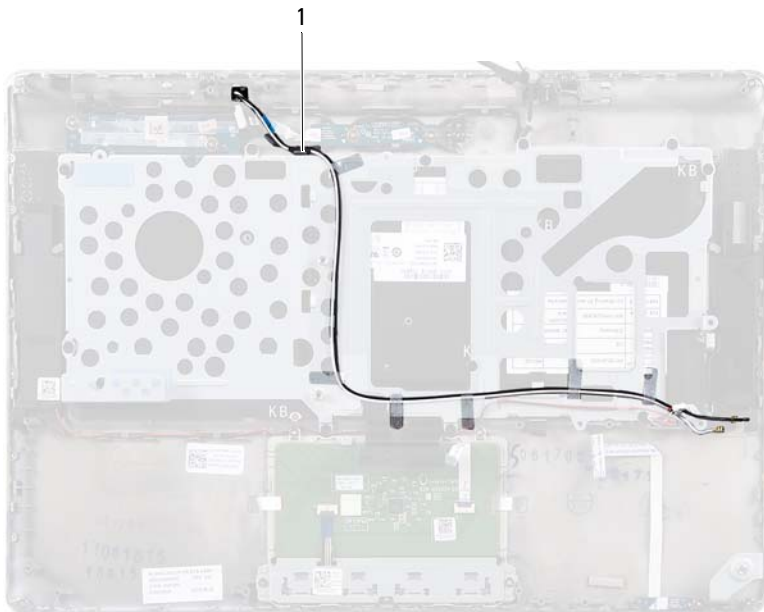

1 antenna cables (2)

6 Lift the keyboard bracket off the palm-rest assembly.

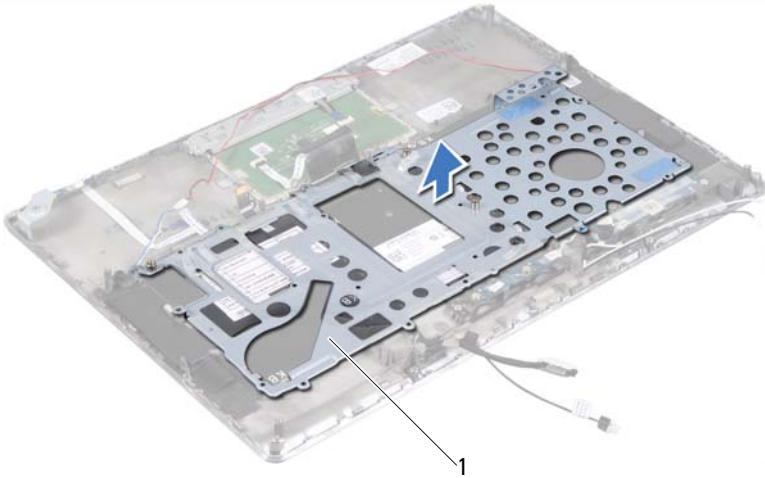

- 1 keyboard bracket

Replacing the Keyboard Bracket

- 1 Follow the instructions in "Before You Begin" on page 7.
- 2 Place the keyboard bracket on the palm-rest assembly.
- 3 Replace the 18 screws that secure the keyboard bracket to the palm-rest assembly.
- 4 Route the speakers cable and antenna cables through the routing guides.
- 5 Replace the system board (see "Replacing the System Board" on page 48).

Removing the Keyboard

- 1 Follow the instructions in "Before You Begin" on page 7.
- 2 Remove the keyboard bracket (see "Removing the Keyboard Bracket" on page 53).

⚠ CAUTION: The keycaps on the keyboard are fragile, easily dislodged, and time-consuming to replace. Be careful when removing and handling the keyboard.

- 3 Lift the keyboard off the palm-rest assembly.

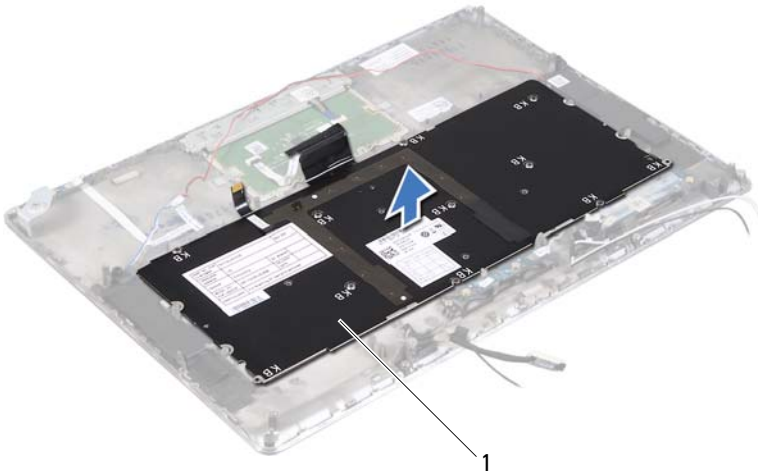

1 keyboard





Replacing the Keyboard

- 1 Follow the instructions in "Before You Begin" on page 7.
- 2 Place the keyboard on the palm-rest assembly.
- 3 Replace the keyboard bracket (see "Replacing the Keyboard Bracket" on page 57).



CAUTION: Before turning on the computer, replace all screws and ensure that no stray screws remain inside the computer. Failure to do so may result in damage to the computer.

Speakers

-  **WARNING:** Before working inside your computer, read the safety information that shipped with your computer. For additional safety best practices information, see the Regulatory Compliance Homepage at www.dell.com/regulatory_compliance.
-  **CAUTION:** Only a certified service technician should perform repairs on your computer. Damage due to servicing that is not authorized by Dell is not covered by your warranty.
-  **CAUTION:** To avoid electrostatic discharge, ground yourself by using a wrist grounding strap or by periodically touching an unpainted metal surface (such as a connector on your computer).
-  **CAUTION:** To help prevent damage to the system board, remove the main battery (see "Removing the Battery" on page 15) before working inside the computer.

Removing the Speakers

- 1 Follow the instructions in "Before You Begin" on page 7.
- 2 Remove the system board (see "Removing the System Board" on page 45).
- 3 Make a note of the antenna cables routing and remove the antenna cables from the routing guides.

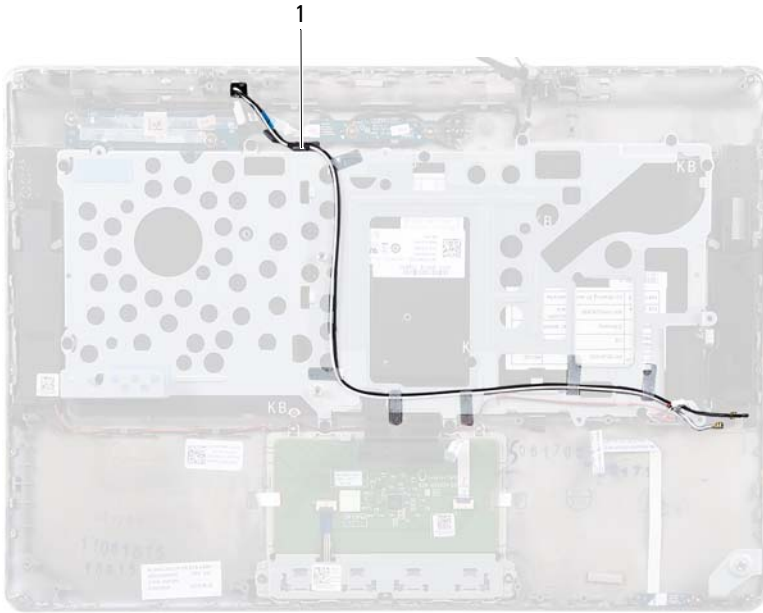

1 antenna cables (2)

4 Make a note of the speakers cable routing and remove the speaker cables from the routing guides.

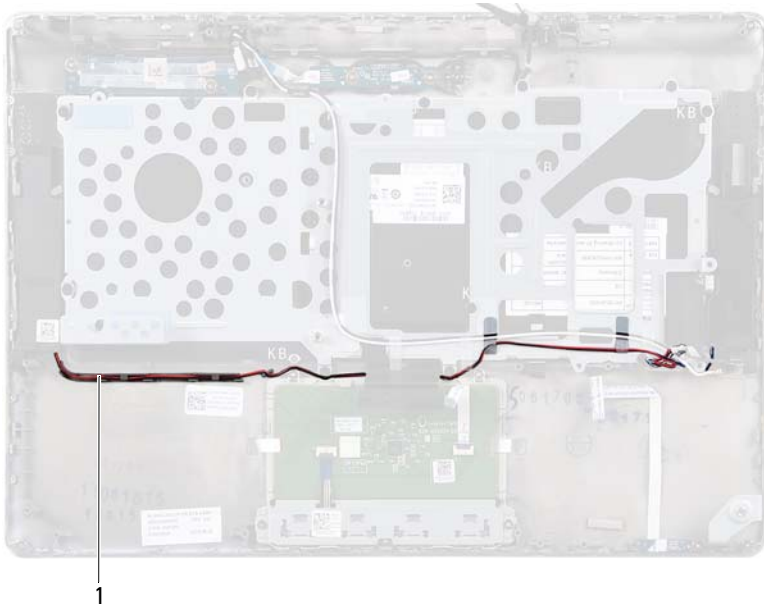

1 speakers cable

- 5** Remove the two screws (one on each side) that secure the speakers to the palm-rest assembly.
- 6** Slide and lift the speakers along with the cable off the palm-rest assembly.

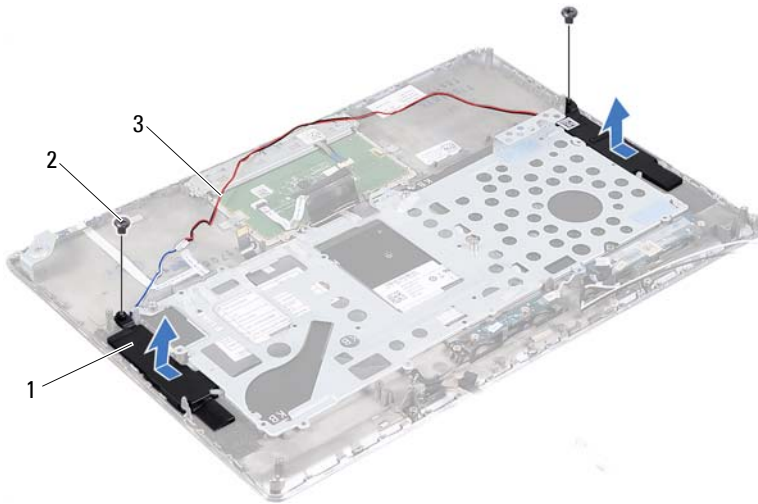

- 1 speakers (2)
- 2 screws (2)
- 3 speakers cable

Replacing the Speakers

- 1 Follow the instructions in "Before You Begin" on page 7.
- 2 Place the speakers on the palm-rest assembly and route the speakers cable through the routing guides.
- 3 Replace the two screws (one on each side) that secure the speakers to the palm-rest assembly.
- 4 Route the antenna cables through the routing guides.
- 5 Replace the system board (see "Replacing the System Board" on page 48).

CAUTION: Before turning on the computer, replace all screws and ensure that no stray screws remain inside the computer. Failure to do so may result in damage to the computer.

Display

 **WARNING:** Before working inside your computer, read the safety information that shipped with your computer. For additional safety best practices information, see the Regulatory Compliance Homepage at www.dell.com/regulatory_compliance.

 **CAUTION:** Only a certified service technician should perform repairs on your computer. Damage due to servicing that is not authorized by Dell is not covered by your warranty.

 **CAUTION:** To avoid electrostatic discharge, ground yourself by using a wrist grounding strap or by periodically touching an unpainted metal surface (such as a connector on your computer).

 **CAUTION:** To help prevent damage to the system board, remove the main battery (see "Removing the Battery" on page 15) before working inside the computer.

Display Hinge Covers

Removing the Display Hinge Covers

- 1 Follow the instructions in "Before You Begin" on page 7.
- 2 Remove the system board (see "Removing the System Board" on page 45).
- 3 Push the eight tabs (four on each side) that secure the display hinge covers to the palm-rest assembly.

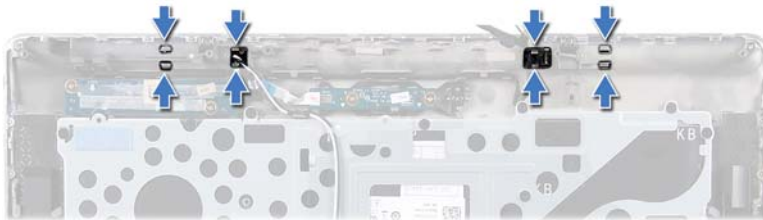

- 4 Turn the palm-rest assembly over.
- 5 Lift the display hinge covers off the palm-rest assembly.



- 1 display hinge covers (2)

Replacing the Display Hinge Covers

- 1 Follow the instructions in "Before You Begin" on page 7.
- 2 Align the tabs on the display hinge covers with the slots on the palm-rest assembly and snap the display hinge covers into place.
- 3 Replace the system board (see "Replacing the System Board" on page 48).

⚠ CAUTION: Before turning on the computer, replace all screws and ensure that no stray screws remain inside the computer. Failure to do so may result in damage to the computer.

Display Assembly

Removing the Display Assembly

- 1 Follow the instructions in "Before You Begin" on page 7.
- 2 Remove the display hinge covers (see "Removing the Display Hinge Covers" on page 65).
- 3 Remove the two screws that secure the display assembly to the palm-rest assembly.
- 4 Carefully push the antenna cables, ambient-light-sensor cable, display cable, and camera cable towards the top of the computer.

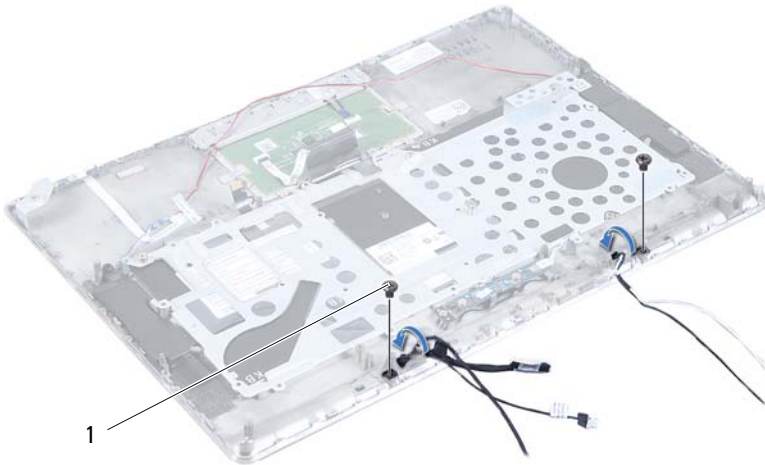

1 screws (2)

- 5 Remove the four screws (two on each side) that secure the display assembly to the palm-rest assembly.
- 6 Slide and lift the display assembly away from the palm-rest assembly.

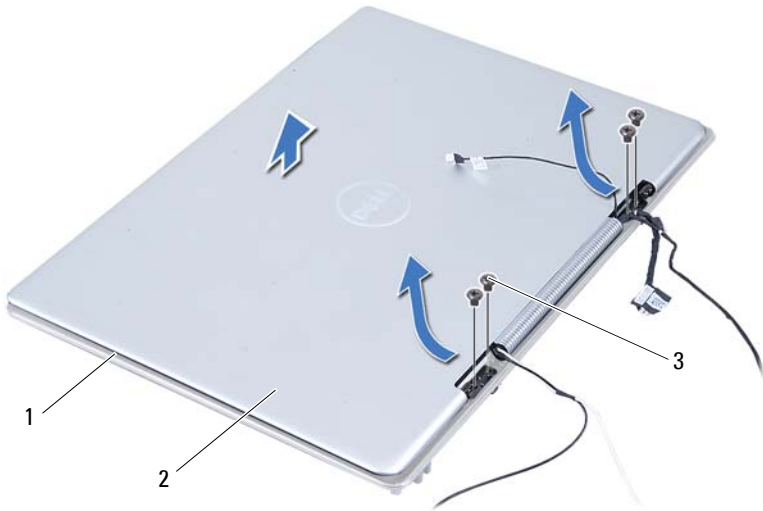

- | | | | |
|---|--------------------|---|------------------|
| 1 | palm-rest assembly | 2 | display assembly |
| 3 | screws (4) | | |

Replacing the Display Assembly





- 1 Follow the instructions in "Before You Begin" on page 7.
- 2 Slide and place the display assembly on the palm-rest assembly.
- 3 Replace the four screws that secure the display assembly to the palm-rest assembly.

- 4 Carefully route the antenna cables, ambient-light-sensor cable, display cable, and camera cable towards the bottom of the computer.
- 5 Replace the two screws that secure the display assembly to the palm-rest assembly.
- 6 Replace the display hinge covers (see "Replacing the Display Hinge Covers" on page 67).



CAUTION: Before turning on the computer, replace all screws and ensure that no stray screws remain inside the computer. Failure to do so may result in damage to the computer.

Palm-Rest Assembly

-  **WARNING:** Before working inside your computer, read the safety information that shipped with your computer. For additional safety best practices information, see the Regulatory Compliance Homepage at www.dell.com/regulatory_compliance.
-  **CAUTION:** Only a certified service technician should perform repairs on your computer. Damage due to servicing that is not authorized by Dell is not covered by your warranty.
-  **CAUTION:** To avoid electrostatic discharge, ground yourself by using a wrist grounding strap or by periodically touching an unpainted metal surface (such as a connector on your computer).
-  **CAUTION:** To help prevent damage to the system board, remove the main battery (see "Removing the Battery" on page 15) before working inside the computer.

Removing the Palm-Rest Assembly

- 1 Follow the instructions in "Before You Begin" on page 7.
 - 2 Remove the system board (see "Removing the System Board" on page 45).
 - 3 Remove the keyboard (see "Removing the Keyboard" on page 58).
 - 4 Remove the speakers (see "Removing the Speakers" on page 61).
 - 5 Remove the power-button board (see "Removing the Power-Button Board" on page 51).
 - 6 Remove the display-converter board (see "Removing the Display-Converter Board" on page 39).
 - 7 Remove the hall-sensor board (see "Removing the Hall-Sensor Board" on page 35).
 - 8 Remove the display assembly (see "Removing the Display Assembly" on page 68).
 - 9 Lift the display assembly off the palm-rest assembly.
-  **CAUTION:** Carefully separate the palm-rest assembly from the display assembly to avoid damage to the display assembly.

Replacing the Palm-Rest Assembly

- 1 Follow the instructions in "Before You Begin" on page 7.
- 2 Replace the display assembly (see "Replacing the Display Assembly" on page 69).
- 3 Replace the hall-sensor board (see "Replacing the Hall-Sensor Board" on page 37).
- 4 Replace the display-converter board (see "Replacing the Display-Converter Board" on page 40).
- 5 Replace the power-button board (see "Replacing the Power-Button Board" on page 52).
- 6 Replace the speakers (see "Replacing the Speakers" on page 64).
- 7 Replace the keyboard (see "Replacing the Keyboard" on page 59).
- 8 Replace the system board (see "Replacing the System Board" on page 48).



CAUTION: Before turning on the computer, replace all screws and ensure that no stray screws remain inside the computer. Failure to do so may result in damage to the computer.

Flashing the BIOS

The BIOS may require flashing when an update is available or when replacing the system board. To flash the BIOS:

- 1 Turn on the computer.
- 2 Go to support.dell.com/support/downloads.
- 3 Locate the BIOS update file for your computer:



NOTE: The Service Tag for your computer is located on a label at the bottom of your computer.

If you have your computer's Service Tag:

- a Click **Enter a Tag**.
- b Enter your computer's Service Tag in the **Enter a service tag:** field, click **Go**, and proceed to step 4.

If you do not have your computer's Service Tag:

- a Click **Select Model**.
- b Select the type of product in the **Select Your Product Family** list.
- c Select the product brand in the **Select Your Product Line** list.
- d Select the product model number in the **Select Your Product Model** list.



NOTE: If you have selected a different model and want to start over again, click **Start Over** on the top right of the menu.

- e Click **Confirm**.
- 4 A list of results appears on the screen. Click **BIOS**.
- 5 Click **Download Now** to download the latest BIOS file.
The **File Download** window appears.

- 6** Click **Save** to save the file on your desktop. The file downloads to your desktop.
- 7** Click **Close** if the **Download Complete** window appears. The file icon appears on your desktop and is titled the same as the downloaded BIOS update file.
- 8** Double-click the file icon on the desktop and follow the instructions on the screen.